

# Tools *for solar professionals*



**RENNSTEIG**

*The Right Tool.*



Catalog 2011

When it's a RENNSTEIG,  
YOU can feel it.



## Manufacturer Index

---

MC3	Page 04	05
	Page 06	07
	Page 10	11
	Page 14	15
	Page 16	17
	Page 18	19
	Page 20	21
	Page 22	23
MC4	Page 04	05
	Page 06	07
	Page 08	09
	Page 10	11
	Page 12	13
	Page 14	15
	Page 16	17
	Page 18	19
	Page 20	21
	Page 28	29
Tyco	Page 04	05
	Page 06	07
	Page 10	11
	Page 12	13
	Page 14	15
	Page 16	17
	Page 18	19
	Page 20	21
Wieland	Page 04	05
	Page 06	07
	Page 08	09
	Page 10	11
	Page 12	13
	Page 14	15
	Page 18	19
Amphenol H4	Page 04	05
	Page 06	07
	Page 10	11
	Page 12	13
	Page 14	15
	Page 18	19
SMK	Page 04	05
	Page 06	07
Lumberg LC3 LC4	Page 04	05
	Page 06	07
	Page 14	15
Yukita	Page 06	07
Huber+Suhner	Page 04	05
	Page 06	07
	Page 12	13
	Page 14	15
	Page 16	17
HTS	Page 06	07
Hirschmann	Page 04	05
	Page 06	07

Double-plated ratchet gear extends tool life



Easy grip even when fully open



Parallel crimping



Locator (for the correct positioning of the specific contact)

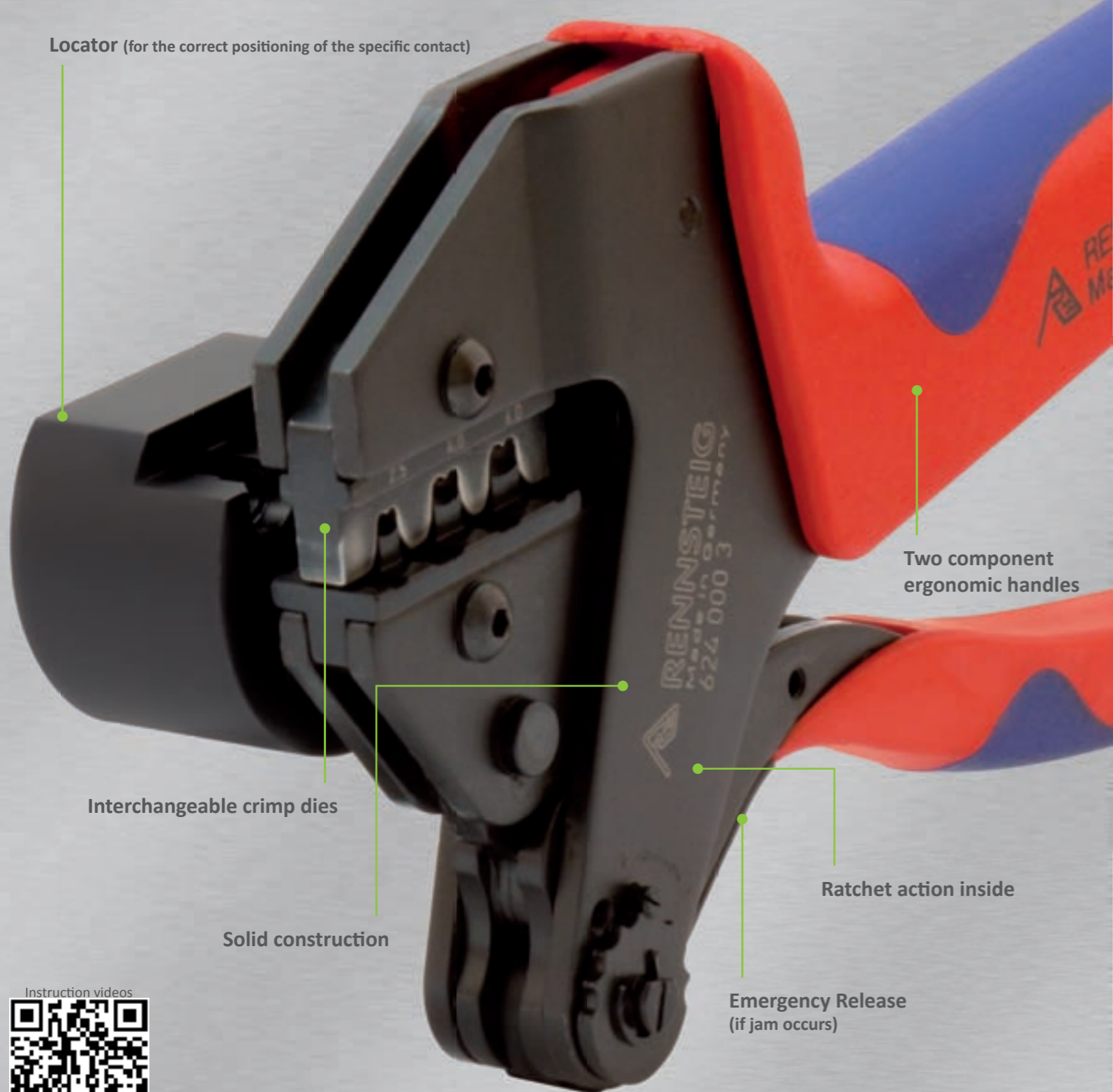

Two component ergonomic handles

Interchangeable crimp dies

Solid construction

Ratchet action inside

Emergency Release (if jam occurs)



Instruction videos

PATENTED

## Solar System Tool

This crimp tool is recommended for crimping solar contacts. The excellent handling, easy exchange of the crimping insert bits and the possibility of adding a positioning aid are facts in favour of these crimping pliers.

- High-precision ratchet mechanism for complete crimps
- 1.2 metric tons pressure at crimping face, with minimal hand effort
- **Interchangeable high-precision Crimping Die Set**
- Parallel jaws for even crimps
- Interchangeable Locator for precision positioning of terminals
- Made in Germany - made by Rennsteig

### For Multi-Contact MC3 (Solarline 1)

Wire Gauge	14/12/10	
Length	8"	
Weight	1.43 lbs. - 1.63 lbs.	
Part #	624 194 3	Tool w/ Die Set
	624 194 3 1	Tool w/ Die Set + Locator
For Wire Gauge 12/10/8	624 348 3	Tool w/ Die Set
	624 348 3 1	Tool w/ Die Set + Locator

### For Multi-Contact MC4 (Solarline 2)

Wire Gauge	14/12/10	
Length	8"	
Weight	1.43 lbs. - 1.72 lbs.	
Part #	624 570 3	Tool w/ Die Set
	624 570 3 1	Tool w/ Die Set + Locator
For Wire Gauge 12/10/8	624 1193 3	Tool w/ Die Set
	624 1193 3 1	Tool w/ Die Set + Locator

### For SMK

Wire Gauge	14/12	
Length	8"	
Weight	1.43 lbs.	
Part #	624 1188 3	Tool w/ Die Set
	624 1188 3 1	Tool w/ Die Set + Locator

### For Wieland (gesis® solar)

Wire Gauge	12/10/8	
Length	8"	
Weight	1.52 lbs. - 1.72 lbs.	
Part #	624 073-1 3	Tool w/ Die Set
	624 073-1 3 16	Tool w/ Die Set + Locator

### For Amphenol H4

Wire Gauge	14/12/10/8	
Length	8"	
Weight	1.43 lbs. - 1.63 lbs.	
Part #:	624 1194 3	Tool w/ Die Set
	624 1194 3 1	Tool w/ Die Set + Locator

### For Huber+Suhner (Radox®-Twist Lock)

Wire Gauge	12/10	
Length	8"	
Weight	1.43 lbs.	
Part #	624 205 3	Tool w/ Die Set

### For Tyco (Solarlok®)

Wire Gauge	16/14/12/10	
Length	8"	
Weight	1.43 lbs. - 1.72 lbs.	
Part #	624 817 3	Tool w/ Die Set
	624 817 3 1	Tool w/ Die Set + Locator

### Also available!

#### For Lumberg LC3

Wire Gauge	14/12/10	
Part #	624 231 3 1	Tool w/ Die Set + Locator

#### For Lumberg LC4

Wire Gauge	14/12/10	
Part #	624 232 3 1	Tool w/ Die Set + Locator

#### For Wieland (gesis® solar)

Wire Gauge	16/14	
Part #	624 071-1 3	Tool w/ Die Set
	624 071-1 3 16	Tool w/ Die Set + Locator

#### For Hirschmann (SunCon™)

Wire Gauge	16/14/12/10	
Part #	624 614 3	Tool w/ Die Set

Other applications on request.

At Rennsteig, we stay on top of the market. When new connectors come out and gain ground, you can be sure we'll make die sets for them. What does this mean? It means you don't have to invest in a whole new crimp tool. You can just get an additional die set to fit your existing crimp tool, and you're ready to install the latest gear.



**Locator**  
(for precise positioning of connector)

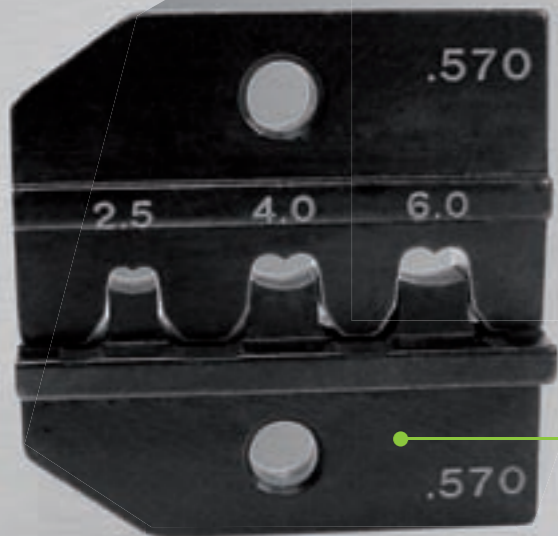

**Interchangeable crimping die set**  
(fits in our Solar System Tool)

## Single components: Tool Frame, Crimping Die Sets & Locators

### Crimping Die Set:

Each type and size of terminals needs its own crimp. Just squeezing it isn't enough - you have to get exactly the right dimension crimp, if you want a good connection that gives good conductivity year after year, under all conditions.

### Locator:

The Locator holds the terminal in the tool so that you don't need 3 hands to make a crimp. But it also does more. It positions the terminal so you always crimp it in the right place, for a high-quality connection every time.

Basic Item		
		
Compatible with all Die Sets and Locators		
Length	1 ½"	
Weight	1.37 lbs.	
Part #	624 000 3	Empty Tool Frame for all Rennsteig Die Sets and Locator

For Multi-Contact MC3 (Solarline 1)		
		
Wire Gauge	14/12/10	
Length	1 ½"	
Weight	0.11 lbs. - 0.18 lbs.	
Part #	624 194 3 0	Die Set only
	624 194 0 01	Locator only
<b>NEW</b> Wire Gauge	624 348 3 0	Die Set only
12/10/8	624 348 0 01	Locator only

For Multi-Contact MC4 (Solarline 2)		
		
Wire Gauge	14/12/10	
Length	1 ¼" - 1 ½"	
Weight	0.11 lbs. - 0.18 lbs.	
Part #	624 570 3 0	Die Set only
	624 570 0 01	Locator only
<b>NEW</b> Wire Gauge	624 1193 3 0	Die Set only
12/10/8	624 1193 0 01	Locator only

For Tyco (Solarlok®)		
		
Wire Gauge	16/14/12/10	
Length	1 ¼" - 1 ½"	
Weight	0.11 lbs. - 0.18 lbs.	
Part #	624 817 3 0	Die Set only
	624 817 0 01	Locator only

For Wieland (gesis® solar)		
		
Wire Gauge	12/10/8	
Length	1 ¼" - 1 ½"	
Weight	0.11 lbs. - 0.18 lbs.	
Part #	624 073-1 3 0	Die Set only
	624 071 0 016	Locator only

For Amphenol H4		
		
Wire Gauge	14/12/10/8	
Length	1 ¼" - 1 ½"	
Weight	0.11 lbs. - 0.18 lbs.	
Part #:	624 1194 3 0	Die Set only
	624 1194 0 01	Locator only

For Huber+Suhner (Radox®-Twist Lock)		
		
Wire Gauge	12/10	
Length	1 ¼"	
Weight	0.11 lbs.	
Part #	624 205 3 0	Die Set only

For SMK		
		
Wire Gauge	14/12	
Length	1 ¼" - 1 ½"	
Weight	0.11 lbs. - 0.18 lbs.	
<b>NEW</b> Part #	624 1188 3 0	Die Set only
	624 1188 0 01	Locator only

### Also available!

For Lumberg LC4		
Wire Gauge	14/12/10	
Part #	624 232 3 0	Die Set only

For Lumberg LC3		
Wire Gauge	14/12/10	
Part #	624 231 3 0	Die Set only

For Yukita		
Wire Gauge	16/14/12/10	
Part #	624 369 3 0	Die Set only

For Hirschmann (SunCon™)		
Wire Gauge	16/14/12/10	
Part #	624 614 3 0	Die Set only

For Wieland (gesis® solar)		
Wire Gauge	16/14	
Part #	624 071-1 3 0	Die Set only

For HTS		
Wire Gauge	16/14/12/10	
Part #	624 072 3 0	Tool w/ Die Set

Other applications on request.

At Rennsteig, we stay on top of the market. When new connectors come out and gain ground, you can be sure we'll make die sets for them. What does this mean? It means you don't have to invest in a whole new crimp tool. You can just get an additional die set to fit your existing crimp tool, and you're ready to install the latest gear.

Double-plated ratchet gear extends tool life



Easy grip even when fully open



Parallel crimping



Locator (for the correct positioning of the specific contact)

Two component ergonomic handles

Solid construction

Emergency Release (if jam occurs)

Ratchet action inside



Instruction video

PATENTED

## CSC Multifunction Tool

No more carrying around 3 different tools, when all you really want to do is make a connection. „CSC“ stands for Cut - Strip - Crimp, and that's what this tool does. *Unique in the industry!*

- For cutting, stripping and crimping of solar contacts with just one tool
- Includes Die Set
- Options include other wire sizes and connector types
- Burnished finish, solid construction, easy to handle
- Made in Germany - made by Rennsteig

### For Multi-Contact MC4 (Solarline 2)

Wire Gauge	12 (similar to 4 mm <sup>2</sup> )	
Length	8"	
Weight	1.43 lbs.	
Part #	624 004 3	Tool w/ Die Set
	624 004 3 1	Tool w/ Die Set + Locator

### For Multi-Contact MC4 (Solarline 2)

Wire Gauge	10 (similar to 6 mm <sup>2</sup> )	
Length	8"	
Weight	1.43 lbs.	
Part #	624 006 3	Tool w/ Die Set
	624 006 3 1	Tool w/ Die Set + Locator

### Spare Parts for MC4

Part #	624 004 3 0	Die Set only (AWG 12)
	624 004 0 01	Loactaor only (AWG 12)
	624 006 3 0	Die Set only (AWG 10)
	624 006 0 01	Locator only (AWG 10)

### For Wieland (gesis® solar)

Wire Gauge	12 (similar to 4 mm <sup>2</sup> )	
Length	8"	
Weight	1.43 lbs.	
Part #	624 1197 3 1	Tool w/ Die Set + Locator

### For Wieland (gesis® solar)

Wire Gauge	10 (similar to 6 mm <sup>2</sup> )	
Length	8"	
Weight	1.43 lbs.	
Part #	624 1196 3 1	Tool w/ Die Set + Locator

### Spare Parts for Wieland

Part #	624 1197 3 0	Die Set only (AWG 12)
	624 1197 0 01	Loactaor only (AWG 12)
	624 1196 3 0	Die Set only (AWG 10)
	624 1196 0 01	Locator only (AWG 10)

For Multi-Contact MC3 or other applications on request.

### Cutting



### Stripping

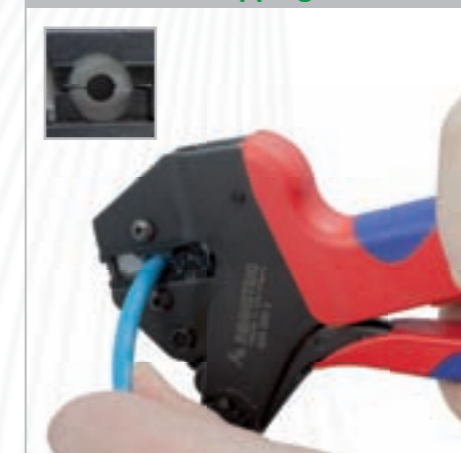

### Crimping

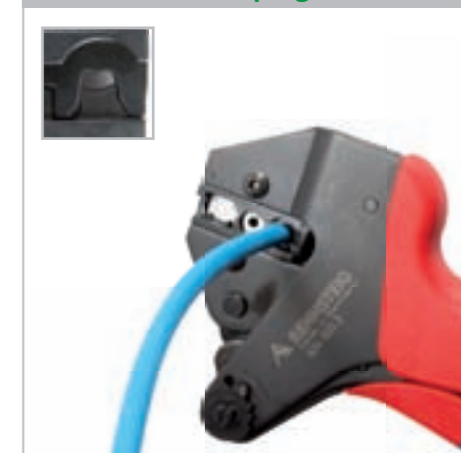

At Rennsteig, we stay on top of the market. When new connectors come out and gain ground, you can be sure we'll make die sets for them. What does this mean? It means you don't have to invest in a whole new crimp tool. You can just get an additional die set to fit your existing crimp tool, and you're ready to install the latest gear.



Protective case

Free space for MC4 Assembly Keys

Solar system tool

Spare parts

Storage space for up to 5 different die sets and locators

Additional storage space



Instruction videos

## Solar Crimp Sets (preassembled)

This professional set has everything you need for making solar wire connections. All components are top-quality Rennsteig tools designed Made in Germany and specially for the solar industry.

Solar Crimp Set for Multi-Contact MC3 (Solarline 1) Multi-Contact MC4 (Solarline 2) Tyco (Solarlok®)	
Content	Crimp Tool MC3-Die Set, MC3-Locator MC4-Die Set, MC4-Locator Tyco-Die Set, Tyco-Locator Spare Parts
Wire Gauge	MC3/MC4 - 14/12/10★ Tyco - 16/14/12/10
Dimension	3 ¼" Height, 13 ½" Length, 10 ¾" Width
Weight	4 lbs.
Part #	624 105-13

Solar Crimp Set for Multi-Contact MC3 (Solarline 1) Multi-Contact MC4 (Solarline 2)	
Content	Crimp Tool MC3-Die Set, MC3-Locator MC4-Die Set, MC4-Locator Spare Parts
Wire Gauge	MC3/MC4 - 14/12/10★
Dimension	3 ¼" Height, 13 ½" Length, 10 ¾" Width
Weight	4 lbs.
Part #	624 105-14

Solar Crimp Set for Multi-Contact MC4 (Solarline 2) Amphenol H4 Wieland (gesis® solar)	
Content	Crimp Tool MC4-Die Set, MC4-Locator H4-Die Set, H4-Locator Wieland-Dei Set, Wieland-Locator, Spare Parts
Wire Gauge	MC4 - 14/12/10★ H4 - 14/12/10/8 Wieland - 12/10/8
Dimension	3 ¼" Height, 13 ½" Length, 10 ¾" Width
Weight	4 lbs.
Part #	624 105-18

Solar Crimp Set for Multi-Contact MC3 (Solarline 1) Multi-Contact MC4 (Solarline 2) Wieland (gesis® solar)	
Content	Crimp Tool MC3-Die Set, MC3-Locator MC4-Die Set, MC4-Locator Wieland-Dei Set, Wieland-Locator, Spare Parts
Wire Gauge	MC3/MC4 - 14/12/10★ Wieland - 12/10/8
Dimension	3 ¼" Height, 13 ½" Length, 10 ¾" Width
Weight	4 lbs.
Part #	624 105-19

Solar Crimp Set for Multi-Contact MC3 (Solarline 1) Multi-Contact MC4 (Solarline 2) Amphenol H4	
Content	Crimp Tool MC3-Die Set, MC3-Locator MC4-Die Set, MC4-Locator H4-Die Set, H4-Locator Spare Parts
Wire Gauge	MC3/MC4 - 14/12/10★ H4 - 14/12/10/8
Dimension	3 ¼" Height, 13 ½" Length, 10 ¾" Width
Weight	4 lbs.
Part #	624 105-20

★ Additional Die Sets for 12/10/8 AWG are separately available. Please take a look at Page 7.

Other applications on request.

At Rennsteig, we stay on top of the market. When new connectors come out and gain ground, you can be sure we'll make die sets for them. What does this mean? It means you don't have to invest in a whole new crimp tool. You can just get an additional die set to fit your existing crimp tool, and you're ready to install the latest gear.



## Solar Crimp Sets (preassembled)

This professional set has everything you need for making solar wire connections. All components are top-quality Rennsteig tools designed Made in Germany and specially for the solar industry.

Now available

Solar Crimp Set for Multi-Contact MC4 (Solarline 2) Tyco (Solarlok®) Wieland (gesis® solar)	
	
Content	Crimp Tool MC4-Die Set, MC4-Locator Tyco-Die Set, Tyco-Locator Wieland-Die Set, Wieland-Locator, Spare Parts
Wire Gauge	MC4 - 14/12/10 ★ Tyco - 16/14/12/10 Wieland - 12/10/8
Dimension	3 ¼" Height, 13 ½" Length, 10 ¾" Width
Weight	4 lbs.
Part #	624 105-21

Now available

Solar Crimp Set for Multi-Contact MC4 (Solarline 2) Amphenol H4 Huber+Suhner (Radox®-Twist Lock)	
	
Content	Crimp Tool MC4-Die Set, MC4-Locator H4-Die Set, H4-Locator H+S-Die Set, H+S-Locator, Spare Parts
Wire Gauge	MC4 - 14/12/10 ★ H4 - 14/12/10/8 Huber+Suhner - 12/10
Dimension	3 ¼" Height, 13 ½" Length, 10 ¾" Width
Weight	4 lbs.
Part #	624 105-22

Now available

Empty Solar Crimp Case for all customers who already own our Crimp System Tool		
Free space for 1 Crimp System Tool, 5 Die Sets, 5 Locator, Additional storage space		
Content	Spare Parts	
Dimension	3 ¼" Height, 13 ½" Length, 10 ¾" Width	
Weight	1.45 lbs.	
Part #	624 105-25	Solar Crimp Set (empty)

**Other applications on request.**  
★ Additional Die Sets for 12/10/8 AWG are separately available. Please take a look at Page 7.

*At Rennsteig, we stay on top of the market. When new connectors come out and gain ground, you can be sure we'll make die sets for them. What does this mean? It means you don't have to invest in a whole new crimp tool. You can just get an additional die set to fit your existing crimp tool, and you're ready to install the latest gear.*

Basic Item	
Empty Tool Frame in portable plastic case	Part # 624 105-12

### Custom Solar Crimp Set „ONE FOR ALL“

Our “Custom Solar Crimp Set “, gives YOU the opportunity to create your own set. With a top-quality Rennsteig Solar System Crimp Tool, Crimp Dies and Locators of your choice, up to 5 different combinations are possible. YOU decide which ones you need. We offer tools for all common manufacturers like Multi-Contact, Tyco, Amphenol, Wieland and many others.

**You decide which ones you need!**

Locators		
Multi-Contact MC3 (Solarline 1)	14/12/10 AWG	Part # 624 194 0 01
	12/10/8 AWG	Part # 624 348 0 01 <b>NEW</b>
Mutli-Contact MC4 (Solarline 2)	14/12/10 AWG	Part # 624 570 0 01
	12/10/8 AWG	Part # 624 1193 0 01 <b>NEW</b>
Amphenol H4	14/12/10/8 AWG	Part # 624 1194 0 01
Tyco (Solarlok®)	16/14/12/10 AWG	Part # 624 817 0 01
Wieland (gesis® solar)	12/10/8 AWG	Part # 624 071 0 016
Lumberg LC3	14/12/10 AWG	Part # 624 231 0 01
Lumberg LC4	14/12/10 AWG	Part # 624 232 0 01
SMK	14/12 AWG	Part # 624 1188 0 01 <b>NEW</b>

Other applications on request.

Die Sets		
Multi-Contact MC3 (Solarline 1)	14/12/10 AWG	Part # 624 194 3 0
	12/10/8 AWG	Part # 624 348 3 0 <b>NEW</b>
Mutli-Contact MC4 (Solarline 2)	14/12/10 AWG	Part # 624 570 3 0
	12/10/8 AWG	Part # 624 1193 3 0 <b>NEW</b>
Amphenol H4	14/12/10/8 AWG	Part # 624 1194 3 0
Tyco (Solarlok®)	16/14/12/10 AWG	Part # 624 817 3 0
Wieland (gesis® solar)	12/10/8 AWG	Part # 624 073-1 3 0
Huber+Suhner (Radox®-Twist Lock)	12/10 AWG	Part # 624 205 3 0
Lumberg LC3	14/12/10 AWG	Part # 624 231 3 0
Lumberg LC4	14/12/10 AWG	Part # 624 232 3 0
SMK	14/12 AWG	Part # 624 1188 3 0 <b>NEW</b>

Other applications on request.



Basic Spare Parts are included in all cases

Assembly Key for MC4 couplers	
Multi-Contact MC4 (Solarline 2)	Part # 690 001

Step by Step
1. Choose your application, you can add a maximum of 5 different Die Sets in the case
2. You can also add a maximum of 5 different Locators in the case
3. If you have added a MC4 Die Set or Locator, you can also add a maximum of 2 Assembly Keys for MC4 couplers.
4. Place an order by using Part# R624 105-12 and the Part#'s shown in the tables after having finished step 1-3.

At Rennsteig, we stay on top of the market. When new connectors come out and gain ground, you can be sure we'll make die sets for them. What does this mean? It means you don't have to invest in a whole new crimp tool. You can just get an additional die set to fit your existing crimp tool, and you're ready to install the latest gear.



A "Must" for Installers

## Professional Solar Wiring/Crimping Kits (preassembled)

Save money...by fabricating your own PV wires. This professional kit has everything you need for making solar wire connections, from cutting to stripping to crimping. All components are top-quality Rennsteig tools designed and made in Germany specially for the solar industry.

Every Kit includes:

- Crimping Die Sets
- Locators (for correct positioning of the terminal)
- Insulation stripper
- Cable cutter
- Different spare parts
- Made in Germany - made by Rennsteig



Solar Wiring/Crimping Kit for Multi-Contact MC3 (Solarline 1) Multi-Contact MC4 (Solarline 2)	
	
Content	Crimp Tool MC3-Die Set, MC3-Locator MC4-Die Set, MC4-Locator Insulation Stripper Cable Cutter RG
Wire Gauge	MC3 - 14/12/10  MC4 - 14/12/10 
Dimension	3 ¼" Height, 13 ½" Length, 10 ¾" Width
Weight	4.80 lbs.
Part #	624 105-02

Solar Wiring/Crimping Kit for Tyco (Solarlok®)	
	
Content	Crimp Tool Tyco-Die Set, Tyco-Locator Insulation Stripper Cable Cutter RG
Wire Gauge	Tyco - 16/14/12/10
Dimension	3 ¼" Height, 13 ½" Length, 10 ¾" Width
Weight	4.58 lbs.
Part #	624 105-03

Solar Wiring/Crimping Kit for Huber+Suhner (Radox®-Twist Lock / Push Pull)	
	
Content	Crimp Tool Huber+Suhner-Die Set Insulation Stripper Cable Cutter RG
Wire Gauge	Huber+Suhner - 14/12/10
Dimension	3 ¼" Height, 13 ½" Length, 10 ¾" Width
Weight	4.52 lbs.
Part #	624 105-04

Other combinations on request.

 Additional Die Sets for 12/10/8 AWG are separately available. Please take a look at Page 7.



At Rennsteig, we stay on top of the market. When new connectors come out and gain ground, you can be sure we'll make die sets for them. What does this mean? It means you don't have to invest in a whole new crimp tool. You can just get an additional die set to fit your existing crimp tool, and you're ready to install the latest gear.

A "Must" for Installers



### Professional Solar Wiring/Crimping Kits (preassembled)

#### Solar Wiring/Crimping Kit for Multi-Contact MC3 (Solarline 1) Multi-Contact MC4 (Solarline 2) Tyco (Solarlok®)

Content	Crimp Tool MC3-Die Set, MC3-Locator MC4-Die Set, MC4-Locator Tyco-Die Set, Tyco-Locator Insulation Stripper Cable Cutter RG
Wire Gauge	MC3 - 14/12/10 ★ MC4 - 14/12/10 ★ Tyco - 16/14/12/10
Dimension	3 ¼" Height, 13 ½" Length, 10 ¾" Width
Weight	4.80 lbs.
Part #	624 105-06

#### Solar Wiring/Crimping Kit for Multi-Contact MC3 (Solarline 1) Multi-Contact MC4 (Solarline 2) Amphenol H4

Content	Crimp Tool MC3-Die Set, MC3-Locator MC4-Die Set, MC4-Locator H4-Die Set, Wieland-Locator Insulation Stripper Cable Cutter RG
Wire Gauge	MC3 - 14/12/10 ★ MC4 - 14/12/10 ★ H4 - 14/12/10/8
Dimension	3 ¼" Height, 13 ½" Length, 10 ¾" Width
Weight	4.94 lbs.
Part #	624 105-15

#### Solar Wiring/Crimping Kit for Multi-Contact MC3 (Solarline 1) Multi-Contact MC4 (Solarline 2) Wieland (gesis® solar)

Content	Crimp Tool MC3-Die Set, MC3-Locator MC4-Die Set, MC4-Locator Wieland-Die Set, Wieland-Locator Insulation Stripper Cable Cutter RG
Wire Gauge	MC3 - 14/12/10 ★ MC4 - 14/12/10 ★ Wieland - 12/10/8
Dimension	3 ¼" Height, 13 ½" Length, 10 ¾" Width
Weight	4.94 lbs.
Part #	624 105-16

#### Solar Wiring/Crimping Kit for Multi-Contact MC4 (Solarline 2) Amphenol H4 Wieland (gesis® solar)

Content	Crimp Tool MC4-Die Set, MC4-Locator H4-Die Set, H4-Locator Wieland-Die Set, Wieland-Locator Insulation Stripper Cable Cutter RG
Wire Gauge	MC4 - 14/12/10 ★ H4 - 14/12/10/8 Wieland - 12/10/8
Dimension	3 ¼" Height, 13 ½" Length, 10 ¾" Width
Weight	4.94 lbs.
Part #	624 105-17

#### Empty Solar Wiring/Crimping Case for all customers who already own our Tools

Free space for - 1 Crimp System Tool - 1 Insulation Stripper - 1 Cable Cutter - 2 Die Sets, 2 Locator	
Content	Spare Parts
Dimension	3 ¼" Height, 13 ½" Length, 10 ¾" Width
Weight	1.45 lbs.
Part #	624 105-26      Solar Kit empty

Other combinations on request.  
★ Additional Die Sets for 12/10/8 AWG are separately available. Please take a look at Page 7.

At Rennsteig, we stay on top of the market. When new connectors come out and gain ground, you can be sure we'll make die sets for them. What does this mean? It means you don't have to invest in a whole new crimp tool. You can just get an additional die set to fit your existing crimp tool, and you're ready to install the latest gear.

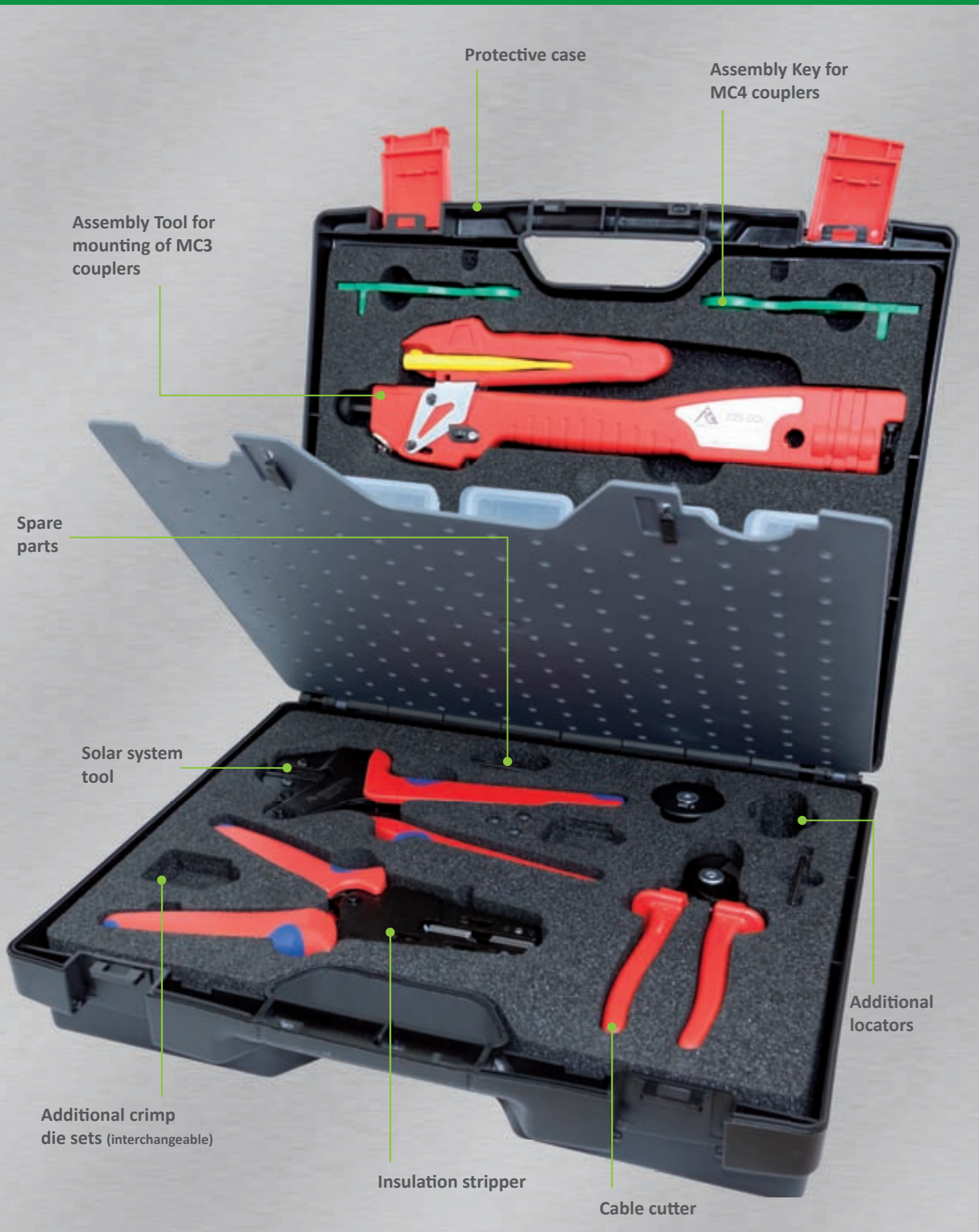

## Professional Solar Wiring/Crimping Kits <sup>Plus</sup> (preassembled)

Save money...by fabricating your own PV wires. This professional kit has everything you need for making solar wire connections, from cutting to stripping to crimping. All components are top-quality Rennsteig tools designed and made in Germany specially for the solar industry.

Every Kit includes:

- Crimping Die Sets
- Locators (for correct positioning of the terminal)
- Insulation stripper
- Assembly Tool for MC3 coupler
- Cable cutter
- Different spare parts
- Made in Germany - made by Rennsteig

### Solar Wiring/Crimping Kit <sup>Plus</sup> for Multi-Contact MC3 (Solarline 1) Multi-Contact MC4 (Solarline 2)



Content	Crimp Tool MC3-Die Set, MC3-Locator MC4-Die Set, MC4-Locator Assembly Tool for mounting of MC3 Couplers Insulation Stripper Cable Cutter RG
Wire Gauge	MC3 - 14/12/10 ★ MC4 - 14/12/10 ★
Dimension	4 ¼" Height, 14" Length, 12 ¾" Width
Weight	7.84 lbs.
Part #	624 105-11

### Solar Wiring/Crimping Kit <sup>Plus</sup> for Multi-Contact MC3 (Solarline 1) Multi-Contact MC4 (Solarline 2) Tyco (Solarlok®)



Content	Crimp Tool MC3-Die Set, MC3-Locator MC4-Die Set, MC4-Locator Tyco-Die Set, Tyco-Locator Assembly Tool for mounting of MC3 Couplers, Insulation Stripper, Cable Cutter RG
Wire Gauge	MC3 - 14/12/10 ★ MC4 - 14/12/10 ★ Tyco - 16/14/12/10
Dimension	4 ¼" Height, 14" Length, 12 ¾" Width
Weight	7.84 lbs.
Part #	624 105-23

### Empty Solar Wiring/Crimping Case <sup>Plus</sup> for all customers who already own our Tools

Free space for  
- 1 Crimp System Tool  
- 1 Insulation Stripper  
- 1 Cable Cutter  
- 2 Die Sets  
- 2 Locator  
- 1 Assembly Tool for mounting MC3 couplers  
Additional storage space

Content	Spare Parts
Dimension	4 ¼" Height, 14" Length, 12 ¾" Width
Weight	4 lbs.
Part #	624 105-28
	Solar Kit <sup>Plus</sup> Empty

Other combinations on request.

★ Additional Die Sets for 12/10/8 AWG are separately available. Please take a look at Page 7.

At Rennsteig, we stay on top of the market. When new connectors come out and gain ground, you can be sure we'll make die sets for them. What does this mean? It means you don't have to invest in a whole new crimp tool. You can just get an additional die set to fit your existing crimp tool, and you're ready to install the latest gear.

FASTER  
BETTER  
EASIER



### Assembly Tool for mounting of MC3 couplers

The MC3 Assembly Tool is a high quality device that is used for inserting the crimped solar PV cable into the rubber housing necessary to fully insulate an MC3 connection.

- Suitable for assembling MC3 connectors from 14/12/10/8 AWG (similar to 2.5/4/6/10 mm<sup>2</sup>)
- Can be used for both male and female connections
- Ergonomic and facile
- Up to 3 spindles can be stored in grip
- Made in Germany - made by Rennsteig

Suitable for on-site use, on roofs, etc.



Assembly Tool for mounting of MC3 couplers		
		
Wire Gauge	14/12/10/8	
Length	13"	
Weight	1.01 lbs.	
Part #	725 00	Complete Tool w/ all spindles for mounting of MC3 couplers

Replacement wire gripper		
Wire Gauge	14/12/10/8	
Part #	725 000 01	Replacement integral wire gripper

Replacement spindle magazine		
Wire Gauge	14/12/10/8	
Part #	725 001	Empty spindle magazine, storage spindle

Replacement spindle, Teflon®		
Wire Gauge	12/10	
Part #	725 002	Spindle

Replacement spindle, Teflon®		
Wire Gauge	10	
Part #	725 003	Spindle

Replacement spindle, Teflon®		
Wire Gauge	8	
Part #	725 004	Spindle

Precise cutting of the insulation to a complete extent.



Positive stripping thanks to precise shape of the blades.



Automatic stripping of the insulation.



Dual component comfort grip handles

Length scale

Adjustable length stop

Head burnished or chromed

Interchangeable stripping blades

PATENTED

## Insulation Stripper with Replaceable Blades

Unlike other strippers that only cut insulation partially and tear the rest, this Rennsteig stripper cuts the insulation around the entire circumference of the wire, and then pulls it gently off the end. There is never any damage to the leads.

Replaceable stripping blades let you configure the stripper to your needs. When the blades wear out, you can replace them without needing to get a new stripper - for significant savings.

- For two-stage stripping action
- Specialized tool with length stop, for precise stripping and dismantling of single and multi-strand cables
- No pinching or deformation of cable ends
- Interchangeable blades for different wire gauges
- **Custom blade design upon request**
- Burnished finish, ergonomically designed two-component handles
- Solid construction, easy to handle
- Made in Germany - made by Rennsteig

### Tool for AWG cable

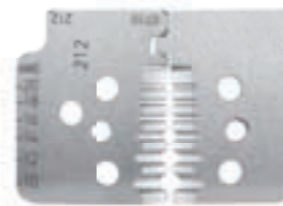

Max. Wire Cross	AWG 20/18/16/14/12/10	
Length	8"	
Weight	0.9 lbs.	
Part #	708 212 3	Tool for AWG cable

### Tool for metric solar cable



Max. Wire Cross	1.5/2.5/4/6 mm <sup>2</sup> (similar to AWG 16/14/12/10)	
Length	8"	
Weight	0.9 lbs.	
Part #	708 226 3	Tool for metric solar cable

### Tool for solar cable



Max. Wire Cross	AWG 16/14/12/10	
Length	8"	
Weight	0.9 lbs.	
Part #	708 226-1 6 RT	Tool for solar cable

### Tool for metric solar cable

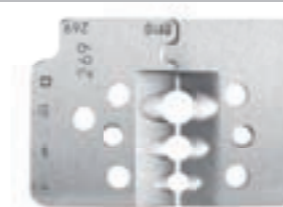

Max. Wire Cross	4/6/10 mm <sup>2</sup> (similar to AWG 12/10/8)	
Length	8"	
Weight	0.9 lbs.	
Part #	708 269 3	Tool for metric solar cable



Two pairs of blades (1) cut the insulation to a complete extent. Then the blade pairs move apart, and thus the insulation is removed form-fit (2). The pliers opens automatically after the stripping procedure.

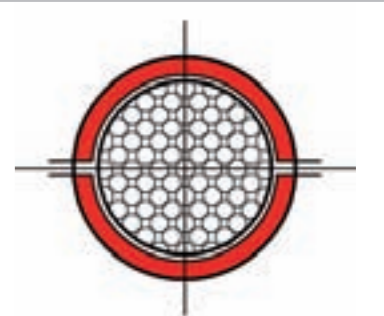

The shaped blades cuts the insulation completely. (The red area will be cut, no damaging of the cable strands)

Already now more than 250 different stripping blades available!  
**Custom blade design upon request.**



**Spring loaded**  
(opening spring inside the tool head)

Special tool steel, forged

Ergonomic grips

Precision ground blades

Safety lock

## Cable Cutter

This specially-designed Rennsteig Cable Cutter gives you clean, straight, burr-free cuts, with no wire end deformation. Wires stay round, so they fit better and more securely in terminals. The ergonomic form factor makes your job easier, too.

- Perfect for cutting almost all cables (\*Not for steel wire or hard-drawn copper cables)
- Plastic coated handles
- Easy, clean, one hand cuts
- Sharp, hardened, precision-ground blades
- No crushing or deformation of cables
- Material: special tool steel, forged
- Made in Germany - made by Rennsteig

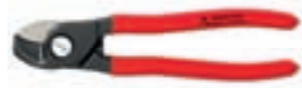
Cable Cutter		
		
Max. Wire Cross	50 mm <sup>2</sup> (similar to AWG 1/0)	
Length	6 ¾"	
Weight	0.5 lbs.	
Part #	700 015 3	burnished, plastic coated

Cable Cutter RG		
		
Max. Wire Cross	50 mm <sup>2</sup> (similar to AWG 1/0)	
Length	6 ¾"	
Weight	0.5 lbs.	
Part #	700 015 36	burnished, reinforced plastic grips

Cable Cutter OS		
		
Max. Wire Cross	50 mm <sup>2</sup> (similar to AWG 1/0)	
Length	6 ¾"	
Weight	0.5 lbs.	
Part #	700 016 3	burnished, spring loaded, plastic coated

Cable Cutter RGO		
		
Max. Wire Cross	50 mm <sup>2</sup> (similar to AWG 1/0)	
Length	6 ¾"	
Weight	0.5 lbs.	
Part #	700 016 36	burnished, spring loaded, plastic grips



We also offer Cutters for larger cable sizes!  
Take a look at our website  
[www.rennsteig.us](http://www.rennsteig.us)

## Assembly key for MC4 couplers

This absolutely ergonomic plastic open end spanner is for tighten and loosen of the cable gland. You can use this key also for breaking connections (open the locking) after they have already been locked together.

To tighten the cable gland, we recommend using two assembly keys.

The Key comes in green.



### Assembly Key for MC4 couplers

Wire Gauge	14/12/10	
Part #	690 001	Complete Tool

## Center Punch

The center punch tool is used to aid in drilling. The impression made by a center punch into wood, plastic or metal marks the area to be drilled and helps the drill stay on course as it goes through the material.

- Made from chrome vanadium steel
- Center Punch shanks are polished and dip-coated in cold lacquer
- Made in Germany - made by Rennsteig
- Hardened striking head won't splinter or "mushroom"
- Complies with German DIN 7250 standard

Center Punch 100		
Body	Diameter 1/2"	
Length	4"	
Weight	0.06 lbs.	
Part #	430 100 0	Center Punch 100, polished

Center Punch 120		
Body	Diameter 1/5"	
Length	4 3/4"	
Weight	0.23 lbs.	
Part #	430 120 0	Center Punch 120, polished

Center Punch 150		
Body	Diameter 3/5"	
Length	6 3/4"	
Weight	0.28 lbs.	
Part #	430 150 0	Center Punch 150, polished

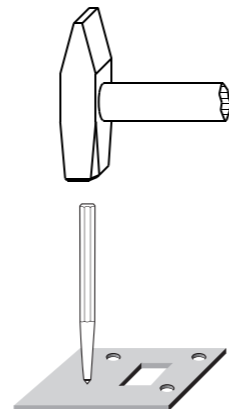

## Adjustable Centering Punches

The best way to determine the center of a hole.

- A better solution compared to a transfer punch
- For exactly, offset-free centering on workpieces
- Perfect alignment of the slitted centering sleeve in masterpiece or drilling jig with knurled screw
- Special hardened and tempered, passing centering punch - resharpenable
- Available in 3 different sizes
- Material: special tool steel
- Made in Germany - made by Rennsteig

Centering Punch I		
Cross section	6 - 8 mm (similar to 0.23" - 0.31")	
Length	3 3/4"	
Weight	0.04 lbs.	
Part #	430 140	Centering Punch I

Centering Punch II		
Cross section	8 - 10 mm (similar to 0.32" - 0.43")	
Length	4 1/4"	
Weight	0.08 lbs.	
Part #	430 141	burnished, reinforced plastic grips

Centering Punch III		
Cross section	11 - 16 mm (similar to 0.43" - 0.62")	
Length	4 1/2"	
Weight	0.17 lbs.	
Part #	430 142	burnished, spring loaded, plastic coated

Centering Punch Set		
Cross section	6 - 16 mm (similar to 0.23" - 0.62")	
Length	6 3/4"	
Weight	0.31 lbs.	
Part #	430 143	Set includes: Centering Punch I, II, III



### Continuously adjustable for different diameters



### Knurled surface for better grip



### Centering Punch Set

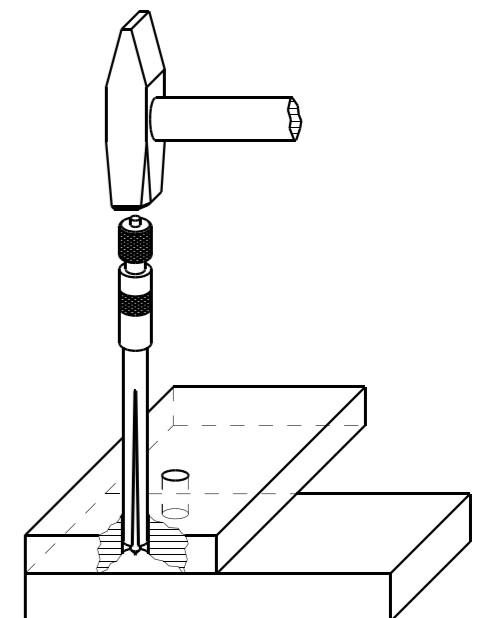

## Automatic Center Punch

The automatic centre punch is a selfstriking tool, used for fast and precise marking. It is mainly used in precision mechanics, steel engineering, by tool makers and for similar applications. The striking force is continuously adjustable.

- Machine steel
- Activated by downward pressure (you don't need a hammer)
- Single handed operation
- Impact force adjustable
- Made in Germany - made by Rennsteig
- Rugged self striking mechanism
- Precision design
- Replaceable hardened pin
- Nickel plated finish



Automatic Center Punch I	
Striking Force	20 - 50 N
Length	3 3/4"
Weight	0.07 lbs.
Part #	430 129      Center Punch I

Automatic Center Punch II	
Striking Force	60 - 130 N
Length	5"
Weight	0.14 lbs.
Part #	430 130      Center Punch II

Automatic Center Punch III	
Striking Force	180 - 250 N
Length	5 1/4"
Weight	0.23 lbs.
Part #	430 131      Center Punch III



## Alignment Pry Bar

- two work ends (Tapers point for aligning holes, pry bar tip for arranging anything)
- Heat-treated ends to resist bending and breaking
- Heavy duty forged steel construction
- Rustproof powder-coat finish
- Made in Germany - made by Rennsteig

Also available, different sizes of Wrecking Bars.

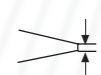

Bar 400	
Pry Bar End	1/5" 
Overall Length	16"
Weight	1.39 lbs.
Part #	473 400 0      Alignment Pry Bar 400

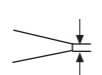
Bar 500	
Pry Bar End	1/5" 
Overall Length	20"
Weight	2.31 lbs.
Part #	473 500 0      Alignment Pry Bar 500

Bar 600	
Pry Bar End	1/5" 
Overall Length	24"
Weight	2.91 lbs.
Part #	473 600 0      Alignment Pry Bar 600



## Dual-Edged Screw Extractor (Easy-Outs)

This Dual-Edged Screw Extractor represents a new generation of his kind used to remove ruined screws or bolts out of threads. The 4 cutting edges of the screw extractor being ground that way only two opposite edges engage with the screw to be removed. This technology provides for use with right-hand and left-hand threads.

- For unscrewing ruined screws and bolts without damaging threads
- Unique design allows both left and right-handed turning
- Extractor is driven into the bore hole for a safe and secure hold
- Integrated center punch pin for precision work
- Non-slip and dual-edged engagement with the screw or bolt to be removed
- Material: chrome vanadium steel, for longer tool life
- Surface: burnished, cutting edges polished
- Made in Germany - made by Rennsteig



PATENTED



Screw Extractor Size 1	
Wrench Size	1/4"
Weight	0.02 lbs
Part #	260 101 3      Screw Extractor Size 1

Screw Extractor Size 2	
Wrench Size	3/8"
Weight	0.04 lbs
Part #	260 102 3      Screw Extractor Size 2

Screw Extractor Size 3	
Wrench Size	1/2"
Weight	0.08 lbs.
Part #	260 103 3      Screw Extractor Size 3

Screw Extractor Size 4	
Wrench Size	5/8"
Weight	0.13 lbs
Part #	260 104 3      Screw Extractor Size 4

Screw Extractor Size 5	
Wrench Size	3/6"
Weight	0.19 lbs
Part #	260 105 3      Screw Extractor Size 5

Vinyl Storage Pouch	
Content	5 Screw Extractors (Size 1 to 5)
Wrench Size	1/4" - 3/6"
Weight	0.51 lbs.
Part #	261 100 3      Screw Extractor Set



## Custom Design

In addition to our standard product line, we offer custom design tooling.

We have the knowledge, skill and capacity to meet any customer specifications, and we specialized in meeting customer requirements.

## Private Label

To enhance our customers marketing position, we offer a private labeling service which provides you the following options:

- Your logo on the tool
- Ergonomic 2- component handles can be varied in color
- Customized labeling



## Stay in touch with us



## Rennsteig Tools, Inc. - Precision Tools Made in Germany



A leading US and German producer of high quality hand tools, Rennsteig Werkzeuge designs and manufactures state of the art crimping, cutting, and stripping tools. The company follows a long tradition of specialty hand tool development and manufacturing which enables it to craft exceptionally dynamic hand tools.

In January 2006, Rennsteig Werkzeuge established Rennsteig Tools Inc. with a sales office in Hudson, Ohio to better serve the North American market (including Canada and Mexico). From this location, the company provides precision tools that conform to USCAR 21 and other North American specifications. Rennsteig Tools Inc. supplies distributors, dealers, OEMs, secondary suppliers and individuals across various industries.

**In November 2009, Rennsteig underscored its commitment to US market with the opening of a new warehouse in Somerdale NJ.**

**In August 2010, Rennsteig moved from Hudson, OH to a new Sales Office in Rutherford, NJ.**

Rennsteig offers the right tools to help you do a professional job, by making electrical connections neat, durable, and fast.



## State-of-the-art production - The core of our company!



Rennsteig can help you streamline your solar installs, by giving you the tools you need to do a fast, professional job. These precision cutting, stripping and crimping tools are specifically engineered for the wires and terminals specific to the solar industry. Our top-quality tools are designed for durability and efficiency, and give you consistently excellent results. RENNSTEIG TOOLS MEET THE REQUIREMENTS OF EVERY PROFESSIONAL USER.

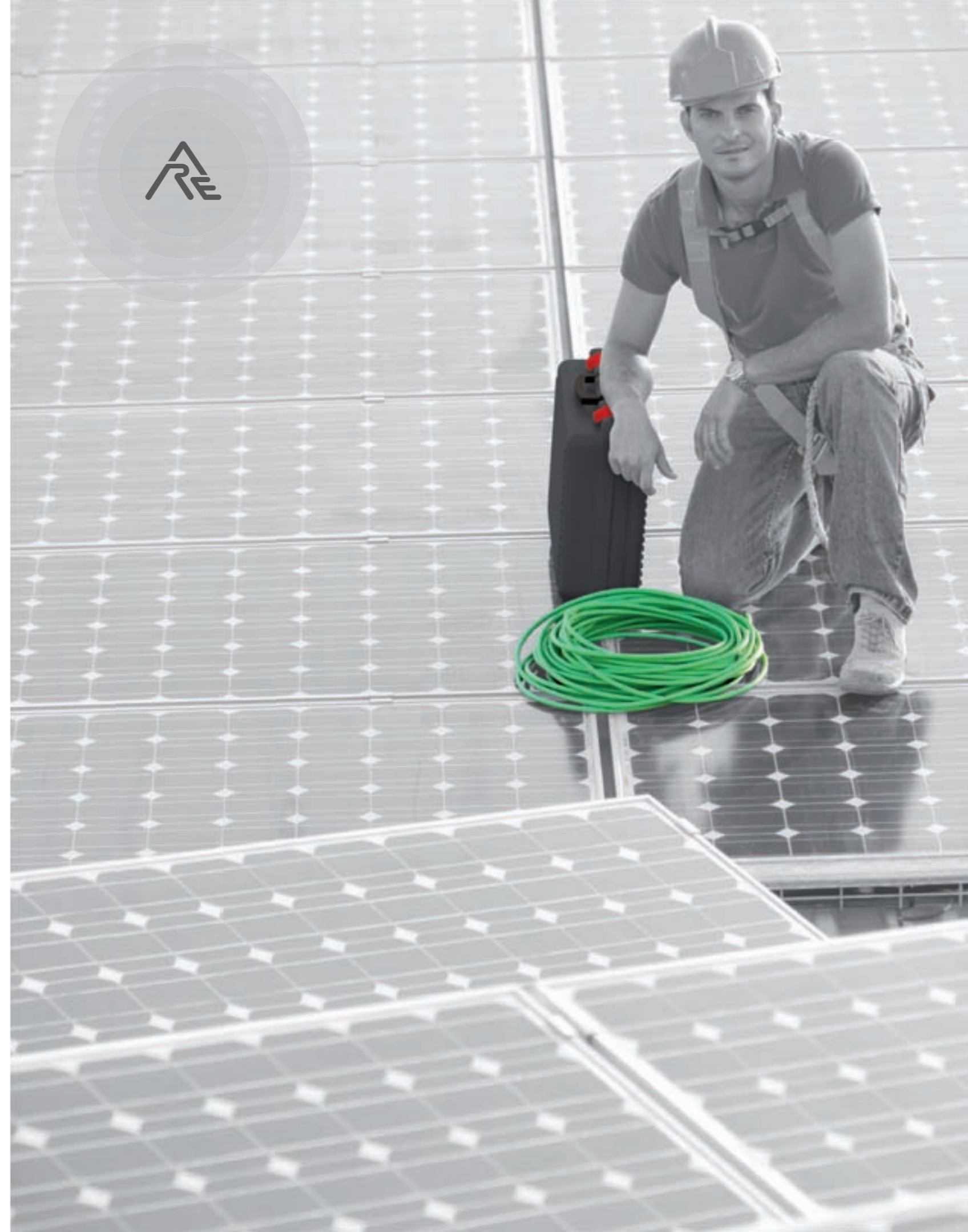

**RENNSTEIG TOOLS, INC.**

*Technical Support*

8079 Castle Rock Dr. NE

Warren, OH 44484

fon: 330-974-0100

mobil: 201-275-5982

web: [www.rennsteig.us](http://www.rennsteig.us)

mail: [robert@rennsteig.us](mailto:robert@rennsteig.us)

**RENNSTEIG TOOLS, INC.**

*Warehouse*

403 Kennedy BLVD

Somerdale, NJ 08083

web: [www.rennsteig.us](http://www.rennsteig.us)

mail: [info@rennsteig.us](mailto:info@rennsteig.us)



**RENNSTEIG TOOLS, INC.**

*Sales Office*

301 Route 17 North, Suite 800

Rutherford, NJ 07070

fon: 330-315-3044

fax: 330-319-8135

mobil: 201-275-5981

web: [www.rennsteig.us](http://www.rennsteig.us)

mail: [sales@rennsteig.us](mailto:sales@rennsteig.us)

**RENNSTEIG WERKZEUGE GMBH**

*Headquarter*

An der Koppel 1

98547 Viernau

fon: 011 49 3 68 47 441 0

fax: 011 49 3 68 47 441 17

web: [www.rennsteig.com](http://www.rennsteig.com)

mail: [info@rennsteig.com](mailto:info@rennsteig.com)



*We are the manufacturer. WE KNOW HOW!*